



中显液晶  
技术资料



型号: ZX4002A

2009年3月15日

北京市海淀区中关村大街32号和盛大厦811室  
电话：(86)-010-52926620 传真：(86)-010-52926621  
企业网站：<http://www.zxlcd.com>

---

## RECORDS OF REVISION

| DATE          | REVISED NO. | REVISED DESCRIPTIONS | PREPARED | CHECKED | APPROVED |
|---------------|-------------|----------------------|----------|---------|----------|
| June 26, 2008 | 1.00        | FIRST ISSUE          | Ynn      |         |          |
|               |             |                      |          |         |          |
|               |             |                      |          |         |          |
|               |             |                      |          |         |          |
|               |             |                      |          |         |          |
|               |             |                      |          |         |          |
|               |             |                      |          |         |          |
|               |             |                      |          |         |          |
|               |             |                      |          |         |          |
|               |             |                      |          |         |          |
|               |             |                      |          |         |          |
|               |             |                      |          |         |          |
|               |             |                      |          |         |          |
|               |             |                      |          |         |          |
|               |             |                      |          |         |          |

---

## CONTENTS

|     |   |    |
|-----|---|----|
| 1.  | GERENAL SPECIFICATIONS .....            | 1  |
| 2.  | FEATURES .....                          | 1  |
| 3.  | MACHANICAL SPECIFICATIONS .....         | 1  |
| 4.  | ABSOLUTE MAXIMUM RATINGS .....          | 2  |
| 5.  | ELECTRICAL CHARACTERISTICS .....        | 2  |
| 6.  | OPTICAL CHARACTERISTICS .....           | 3  |
| 7.  | TIMING CHARACTERISTICS .....            | 4  |
| 8.  | PIN ASSIGNMENT .....                    | 5  |
| 9.  | OUTLINE DIMENSIONS .....                | 5  |
| 10. | RELIABILITY .....                       | 5  |
| 11. | QUALITY GUARANTEE .....                 | 7  |
| 12. | INSPECTION CRITERIA .....               | 7  |
| 13. | PRECAUTIONS FOR USING LCD MODULES ..... | 10 |
| 14. | USING LCD MODULES .....                 | 12 |

## 1. GENERAL SPECIFICATIONS :

### 1-1 SCOPE:

This specification covers the delivery requirements for the liquid crystal display delivered by YAOYU TECHNOLOGY to Customer .

### 1-2 PRODUCTS:

Liquid Crystal Display Module (LCM)

### 1-3 MODULE NAME:

**X4002ADPSWWN**

## 2. FEATURES

| Item              | Standard Value   |
|-------------------|--|
| Display Type      | 40 *2 Characters   |
| LCD Type          | <input type="checkbox"/> FSTN, Transmissive,Negative,Extened TEMP<br><input checked="" type="checkbox"/> FSTN, Transflective,Positive,Extened TEMP<br><input type="checkbox"/> STN, BLUE,Transmissive,Negative,Extened TEMP<br><input type="checkbox"/> STN, GREY,Transflective,Positive,Extened TEMP<br><input type="checkbox"/> STN, Yellow-GREEN,Positive,Extended TEMP |
| Drive Pattern     | 1/16Duty, 1/5Bias  |
| Viewing Direction | 6 O'clock  |
| Backlight Type    | <input type="checkbox"/> YELLOW-GREEN LED BOTTOM BL<br><input checked="" type="checkbox"/> WHITE EDGE LED BL<br><input type="checkbox"/> CCFL WHITE BL   |
| Weight            | TBD  |
| Interface         | 8-bit 6800/8080 MPU interface  |
| Driver IC         | SPLC780/KS0066U  |

## 3. MACHANICAL SPECIFICATIONS

| ITEM                   | STANDARD VALUE               | UNIT |
|------------------------|------------------------------|------|
| DISPLAY FORMAT         | 40 X 2 Characters            |      |
| MODULE DIMENSION       | 182.0(W) X 33.5(H) X 14.0(T) | mm   |
| EFFECTTVE DISPLAY AREA | 149.45(W) X11.5(H)           | mm   |
| DOT SIZE               | 3.2(W) X 5.55(H)             | mm   |
| DOT PITCH              | 3.7(W) X 5.95(H)             | mm   |

|                   |                     |
|-------------------|---------------------|
| LCD TYPE          | FSTN                |
| DUTY AND BIAS     | 1/16 DUTY; 1/5 BIAS |
| VIEWING DIRECTION | 6:00                |
| BACK LIGHT        | WHITE EDGE LED      |

#### 4. ABSOLUTE MAXIMUM RATING

| ITEM                         | SYMBOL         | CONDITION  | STANDARD VALUE |     |         | UNIT |
|------------------------------|----------------|------------|----------------|-----|---------|------|
|                              |                |            | MIN            | TYP | MAX     |      |
| POWER SUPPLY FOR LOGIC       | VDD            | Ta=25°C    | -0.3           | —   | 7.0     | V    |
| INPUT VOLTAGE                | VIN            | Ta=25°C    | -0.3           | —   | VDD+0.3 | V    |
| Module OPERATION TEMPERATURE | TOPR           | ---        | -10            | —   | +60     | °C   |
| Module STORAGE TEMPERATURE   | TSTG           | ---        | -20            | —   | +70     | °C   |
| Storage Humidity             | H <sub>D</sub> | Ta < 40 °C | -              |     | 90      | %RH  |

#### 5. ELECTRICAL CHARACTERISTICS

| ITEM                   | SYMBOL  | CONDITION       | MIN     | TYP | MAX     | UNIT |
|------------------------|---------|-----------------|---------|-----|---------|------|
| Supply Voltage (logic) | Vdd-Vss | -               | 4.5     | 5.0 | 5.5     | V    |
| Supply Voltage (LCD)   | Vlcd    | Vdd=3.3V (25°C) | -       | 4.7 | -       | V    |
| Input signal voltage   | V-ih    | “H” level       | 0.2VDD  | -   | 0.8VDD  | V    |
|                        | V-il    | “L” level       | -0.3    | -   | 0.8     | V    |
| Output signal voltage  | V-oh    | “H” level       | Vdd-0.6 | -   | -       | V    |
|                        | V-ol    | “H” level       | 0       | -   | GND+0.6 | V    |
| Supply Current (logic) | Icc     | -               | -       | 2.0 | 3.0     | mA   |
| Supply Voltage (LED)   | V-bl    |                 | -       | 5.0 | -       | V    |
| Supply Current (LED)   | I-bl    |                 | -       | -   |         | mA   |

## 6. OPTICAL CHARACTERISTICS

### (1) DEFINITION OF VIEWING ANGLE

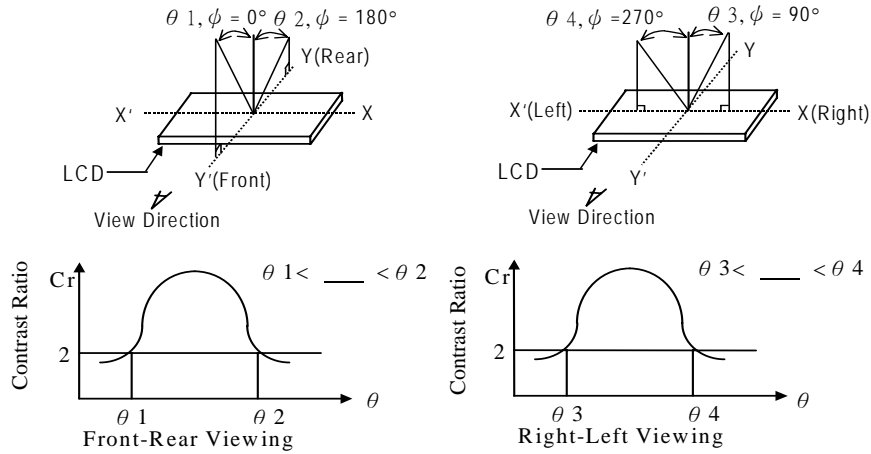

### (2) DEFINITION OF CONTRAST

$$C.R = \frac{\text{Brightness of non-selected segment (B2)}}{\text{Brightness of selected segment (B1)}}$$

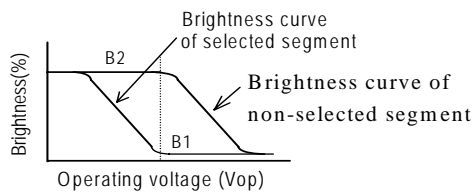

### (3) DEFINITION OF RESPONSE

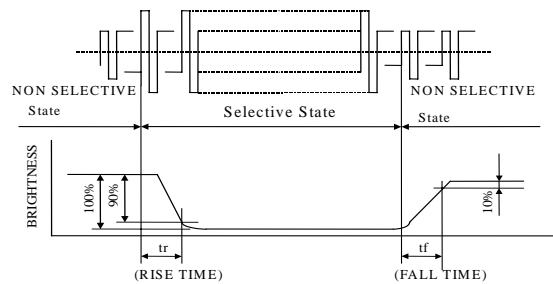

### (4) Measuring Instruments For Electro-optical Characteristics

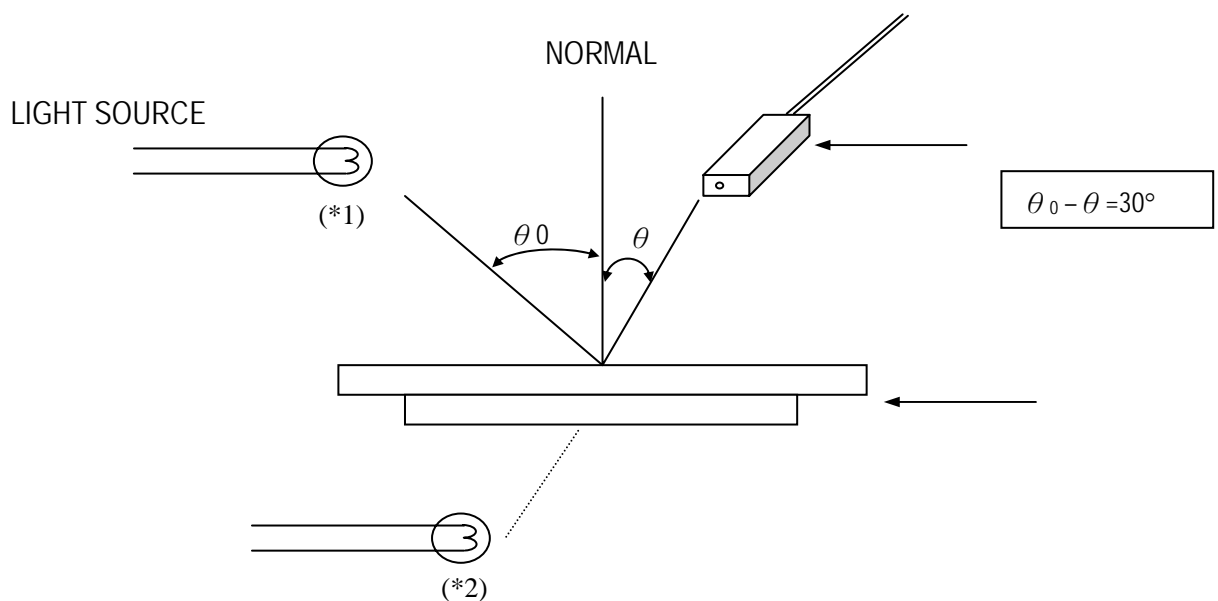

## 7.0 TIMING CHARACTERISTICS

### MPU Interface

| Characteristic         | Symbol    | Min  | Typ | Max | Unit |
|------------------------|-----------|------|-----|-----|------|
| E Cycle                | $t_c$     | 1000 | -   | -   | ns   |
| E High Level Width     | $t_{WH}$  | 450  | -   | -   | ns   |
| E Low Level Width      | $t_{WL}$  | 450  | -   | -   | ns   |
| E Rise Time            | $t_R$     | -    | -   | 25  | ns   |
| E Fall Time            | $t_F$     | -    | -   | 25  | ns   |
| Address Set-Up Time    | $t_{ASU}$ | 140  | -   | -   | ns   |
| Address Hold Time      | $t_{AH}$  | 10   | -   | -   | ns   |
| Data Set-Up Time       | $t_{DSU}$ | 200  | -   | -   | ns   |
| Data Delay Time        | $t_D$     | -    | -   | 320 | ns   |
| Data Hold Time (Write) | $t_{DHW}$ | 10   | -   | -   | ns   |
| Data Hold Time (Read)  | $t_{DHR}$ | 20   | -   | -   | ns   |

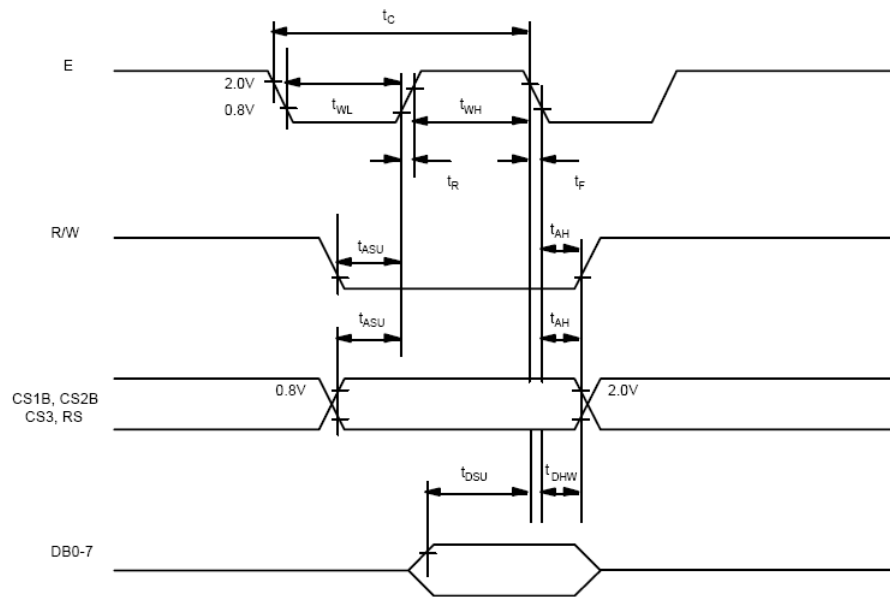

Figure 1. Write timing

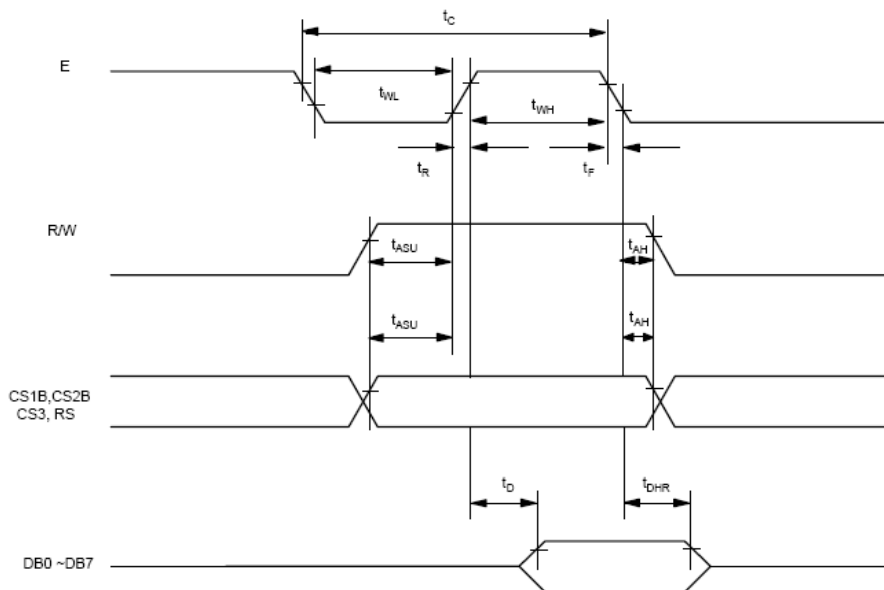
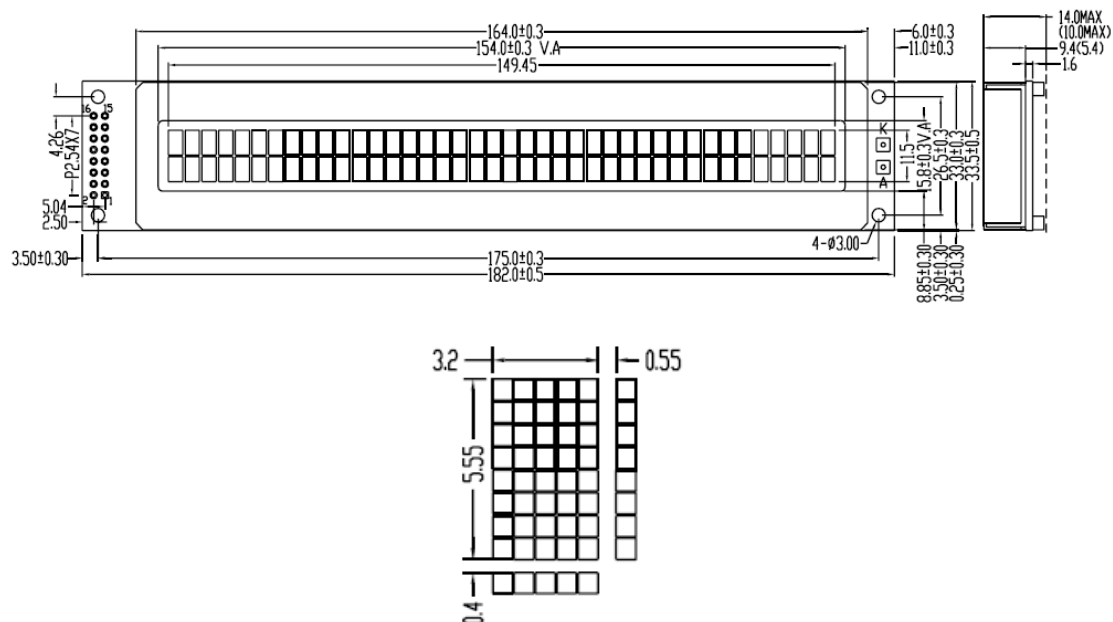

Figure 2. Read Timing

## 8. PIN ASSIGNMENT

| PIN NO. | Symbol | Level | Function   |
|---------|--------|-------|--|
| 1       | VSS    | 0V    | Ground for Logic   |
| 2       | VDD    | +5.0V | Power supply for Logic                                     |
| 3.      | V0     | +4.7V | Power supply for LCD Drive                                 |
| 4.      | RS     | H/L   | Register selection(H:Data Register,L:Instruction Register) |
| 5.      | R/W    | H/L   | Read/Write selection(H:Read,L:Write)                       |
| 6.      | E      | H/L   | Enable signal for LCM                                      |
| 7.      | DB0    | H/L   | Data bit 0   |
| 8.      | DB1    | H/L   | Data bit 1   |
| 9.      | DB2    | H/L   | Data bit 2   |
| 10.     | DB3    | H/L   | Data bit 3   |
| 11.     | DB4    | H/L   | Data bit 4   |
| 12.     | DB5    | H/L   | Data bit 5   |
| 13.     | DB6    | H/L   | Data bit 6   |
| 14.     | DB7    | H/L   | Data bit 7   |
| 15.     | A      | ---   | Backlight(+5.0V)   |
| 16.     | K      | ---   | Backlight(0V)  |

## 9. OUTLINE DIMENSIONS



## 10. RELIABILITY

### Content of Reliability Test

Environmental Test



| No.                    | Test Item                           | Content of Test  | Test Condition   | Applicable Standard                          |
|------------------------|-------------------------------------|--|--|--|
| 1                      | High temperature storage            | Endurance test applying the high storage temperature for a long time.  | 80 °C<br>200 hrs   |  |
| 2                      | Low temperature storage             | Endurance test applying the low storage temperature for a long time.   | -30 °C<br>200 hrs  |  |
| 3                      | High temperature operation          | Endurance test applying the electric stress (Voltage & Current) and the thermal stress to the element for a long time.   | 70 °C<br>200 hrs   |  |
| 4                      | Low temperature operation           | Endurance test applying the electric stress under low temperature for a long time.   | -20 °C<br>200 hrs  |  |
| 5                      | High temperature Humidity storage   | Endurance test applying the high temperature and high humidity storage for a long time.  | 50 °C , 90%<br>RH<br>96 hrs  | MIL-202E-103B<br>JIS-C5023                   |
| 6                      | High temperature Humidity operation | Endurance test applying the electric stress (Voltage & Current) and temperature humidity stress to the element for a long time.  | 50 °C , 90%<br>RH<br>96 hrs  | MIL-202E-103B<br>JIS-C5023                   |
| 7                      | Temperature cycle                   | Endurance test applying the low and high temperature cycle.<br><div style="text-align: center;"> <math display="block">  \begin{array}{c}  -20^{\circ}\text{C} \quad 25^{\circ}\text{C} \quad 70^{\circ}\text{C} \\  \leftarrow 30\text{min.} \rightleftharpoons 5\text{min.} \rightleftharpoons 30\text{min.} \rightarrow \\  \text{1 cycle}  \end{array}  </math> </div> | -20°C – 70°C<br>10 cycles  |  |
| <b>Mechanical Test</b> |                                     |  |  |  |
| 8                      | Vibration test                      | Endurance test applying the vibration during transportation and using.   | 10-22Hz →<br>1.5mmp-p<br>22-500Hz<br>→ 1.5G<br>Total 0.5hrs          | MIL-202E-201A<br>JIS-C5025<br>JIS-C7022-A-10 |
| 9                      | Shock test                          | Constructional and mechanical endurance test applying the shock during transportation.   | 50G half sign<br>wave 1l<br>msedc 3<br>times of<br>each<br>direction | MIL-202E-213B                                |

|               |                           |  |   |                 |
|---------------|---------------------------|--|---|-----------------|
| 10            | Atmospheric pressure test | Endurance test applying the atmospheric pressure during transportation by air. | 115 mbar 40 hrs                             | MIL-202E-105C   |
| <b>Others</b> |                           |  |   |                 |
| 11            | Static electricity test   | Endurance test applying the electric stress to the terminal.                   | VS=800V,<br>RS=1.5 k<br>CS=100 pF<br>1 time | MIL-883B-3015.1 |

Supply voltage for logic system = 3V. Supply voltage for LCD system = Operating voltage at 25°C.

## 11. QUALITY GUARANTEE

### Acceptable Quality Level

Each lot should satisfy the quality level defined as follows.

- Inspection method : MIL-STD-105E LEVEL II Normal one time sampling
- AQL

| Partition | AQL  | Definition   |
|-----------|------|--|
| A: Major  | 0.4% | Functional defective as product                                    |
| B: Minor  | 1.5% | Satisfy all functions as product but not satisfy cosmetic standard |

### Definition of 'LOT'

One lot means the delivery quantity to customer at one time.

### Conditions of Cosmetic Inspection

#### Environmental condition

The inspection should be performed at the 1cm of height from the LCD module under 2 pieces of 40W white fluorescent lamps (Normal temperature 20~25°C and normal humidity 60 ± 15%RH).

#### Inspection method

The visual check should be performed vertically at more than 30cm distance from the LCD panel.

#### Driving voltage

The VO value which the most optimal contrast can be obtained near the specified VO in the specification. (Within ± 0.5V of typical value at 25°C.).

## 12. INSPECTION CRITERIA

### 12.1 Module Cosmetic Criteria

| No. | Item | Judgment Criterion | Partition |
|-----|------|--------------------|-----------|
|-----|------|--------------------|-----------|

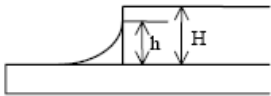
|          |                                      |   |                         |
|----------|--------------------------------------|---|-------------------------|
| 1        | Difference in Spec.                  | None allowed  | Major                   |
| 2        | Pattern peeling                      | No substrate pattern peeling and floating   | Major                   |
| 3        | Soldering defects                    | No soldering missing<br>No soldering bridge<br>No cold soldering  | Major<br>Major<br>Major |
| 4        | Resist flaw on substrate             | Invisible copper foil ('0.5mm or more) on substrate pattern   | Minor                   |
| 5        | Accretion of metallic Foreign matter | No soldering dust No accretion of metallic foreign matters (Not exceed '0.2mm)  | Minor<br>Minor          |
| 6        | Stain                                | No stain to spoil cosmetic badly  | Minor                   |
| 7        | Plate discoloring                    | No plate fading, rusting and discoloring  | Minor                   |
| 8        | Solder amount                        | a. Soldering side of PCB<br>Solder to form a 'Filet' all around the lead.<br>Solder should not hide the lead form perfectly. (too much) | Minor                   |
|          | 1. Lead parts                        | b. Components side<br>( In case of 'Through Hole PCB' )<br><br>Solder to reach the Components side of PCB.                              |                         |
|          | 2. Flat packages                     | Either 'Toe' (A) or 'Seal' (B) of the lead to be covered by 'Filet'.<br><br>Lead form to be assume over solder. A B                     |                         |
| 3. Chips | $(3/2) H \geq h \geq (1/2) H$        |   | Minor                   |

### 12.2 Screen Cosmetic Criteria (Non-Operating)

| No.                | Defect                        | Judgment Criterion   | Partition   |                               |              |           |                    |   |                    |   |           |   |       |
|--------------------|-------------------------------|--|-------------|-------------------------------|--------------|-----------|--------------------|---|--------------------|---|-----------|---|-------|
| 1                  | Spots                         | In accordance with <i>Screen Cosmetic Criteria (Operating) No.1.</i>   | Minor       |                               |              |           |                    |   |                    |   |           |   |       |
| 2                  | Lines                         | In accordance with <i>Screen Cosmetic Criteria (Operating) No.2.</i>   | Minor       |                               |              |           |                    |   |                    |   |           |   |       |
| 3                  | Bubbles in polarizer          | <table border="1"> <thead> <tr> <th>Size : d mm</th> <th>Acceptable Qty in active area</th> </tr> </thead> <tbody> <tr> <td><math>d \leq 0.3</math></td> <td>Disregard</td> </tr> <tr> <td><math>0.3 &lt; d \leq 1.0</math></td> <td>3</td> </tr> <tr> <td><math>1.0 &lt; d \leq 1.5</math></td> <td>1</td> </tr> <tr> <td><math>1.5 &lt; d</math></td> <td>0</td> </tr> </tbody> </table> | Size : d mm | Acceptable Qty in active area | $d \leq 0.3$ | Disregard | $0.3 < d \leq 1.0$ | 3 | $1.0 < d \leq 1.5$ | 1 | $1.5 < d$ | 0 | Minor |
| Size : d mm        | Acceptable Qty in active area |  |             |                               |              |           |                    |   |                    |   |           |   |       |
| $d \leq 0.3$       | Disregard                     |  |             |                               |              |           |                    |   |                    |   |           |   |       |
| $0.3 < d \leq 1.0$ | 3                             |  |             |                               |              |           |                    |   |                    |   |           |   |       |
| $1.0 < d \leq 1.5$ | 1                             |  |             |                               |              |           |                    |   |                    |   |           |   |       |
| $1.5 < d$          | 0                             |  |             |                               |              |           |                    |   |                    |   |           |   |       |

|   |                   |   |       |
|---|-------------------|---|-------|
| 4 | Scratch           | In accordance with spots and lines operating cosmetic criteria. When the light reflects on the panel surface, the scratches are not to be remarkable. | Minor |
| 5 | Allowable density | Above defects should be separated more than 30mm each other.  | Minor |
| 6 | Coloration        | Not to be noticeable coloration in the viewing area of the LCD panels. Back-lit type should be judged with back-lit on state only.                    | Minor |
| 7 | Contamination     | Not to be noticeable.   | Minor |

### 12.3. Screen Cosmetic Criteria (Operating)

| No.                | Defect                        | Judgment Criterion   | Partition   |                               |              |           |                    |   |                    |   |           |   |             |                               |              |           |                    |   |                    |   |           |   |       |
|--------------------|-------------------------------|--|-------------|-------------------------------|--------------|-----------|--------------------|---|--------------------|---|-----------|---|-------------|-------------------------------|--------------|-----------|--------------------|---|--------------------|---|-----------|---|-------|
| 1                  | Spots                         | <p>A) Clear Note :</p> <table border="1"> <thead> <tr> <th>Size : d mm</th> <th>Acceptable Qty in active area</th> </tr> </thead> <tbody> <tr> <td><math>d \leq 0.1</math></td> <td>Disregard</td> </tr> <tr> <td><math>0.1 &lt; d \leq 0.2</math></td> <td>3</td> </tr> <tr> <td><math>0.2 &lt; d \leq 0.3</math></td> <td>2</td> </tr> <tr> <td><math>0.3 &lt; d</math></td> <td>0</td> </tr> </tbody> </table> <p>Including pin holes and defective dots which must be within one pixel size.</p> <p>B) Unclear Size :</p> <table border="1"> <thead> <tr> <th>Size : d mm</th> <th>Acceptable Qty in active area</th> </tr> </thead> <tbody> <tr> <td><math>d \leq 0.2</math></td> <td>Disregard</td> </tr> <tr> <td><math>0.2 &lt; d \leq 0.5</math></td> <td>6</td> </tr> <tr> <td><math>0.5 &lt; d \leq 0.7</math></td> <td>2</td> </tr> <tr> <td><math>0.7 &lt; d</math></td> <td>0</td> </tr> </tbody> </table> | Size : d mm | Acceptable Qty in active area | $d \leq 0.1$ | Disregard | $0.1 < d \leq 0.2$ | 3 | $0.2 < d \leq 0.3$ | 2 | $0.3 < d$ | 0 | Size : d mm | Acceptable Qty in active area | $d \leq 0.2$ | Disregard | $0.2 < d \leq 0.5$ | 6 | $0.5 < d \leq 0.7$ | 2 | $0.7 < d$ | 0 | Minor |
| Size : d mm        | Acceptable Qty in active area |  |             |                               |              |           |                    |   |                    |   |           |   |             |                               |              |           |                    |   |                    |   |           |   |       |
| $d \leq 0.1$       | Disregard                     |  |             |                               |              |           |                    |   |                    |   |           |   |             |                               |              |           |                    |   |                    |   |           |   |       |
| $0.1 < d \leq 0.2$ | 3                             |  |             |                               |              |           |                    |   |                    |   |           |   |             |                               |              |           |                    |   |                    |   |           |   |       |
| $0.2 < d \leq 0.3$ | 2                             |  |             |                               |              |           |                    |   |                    |   |           |   |             |                               |              |           |                    |   |                    |   |           |   |       |
| $0.3 < d$          | 0                             |  |             |                               |              |           |                    |   |                    |   |           |   |             |                               |              |           |                    |   |                    |   |           |   |       |
| Size : d mm        | Acceptable Qty in active area |  |             |                               |              |           |                    |   |                    |   |           |   |             |                               |              |           |                    |   |                    |   |           |   |       |
| $d \leq 0.2$       | Disregard                     |  |             |                               |              |           |                    |   |                    |   |           |   |             |                               |              |           |                    |   |                    |   |           |   |       |
| $0.2 < d \leq 0.5$ | 6                             |  |             |                               |              |           |                    |   |                    |   |           |   |             |                               |              |           |                    |   |                    |   |           |   |       |
| $0.5 < d \leq 0.7$ | 2                             |  |             |                               |              |           |                    |   |                    |   |           |   |             |                               |              |           |                    |   |                    |   |           |   |       |
| $0.7 < d$          | 0                             |  |             |                               |              |           |                    |   |                    |   |           |   |             |                               |              |           |                    |   |                    |   |           |   |       |
| 2                  | Lines                         | <p>A) Clear</p> <p>Note : ( ) - Acceptable Qty in active area L<br/> - Length (mm) W - Width (mm)<br/> <math>\infty</math> - Disregard</p> <p>B) Unclear</p>   | Minor       |                               |              |           |                    |   |                    |   |           |   |             |                               |              |           |                    |   |                    |   |           |   |       |

'Clear' = The shade and size are not changed by VO.  
 'Unclear' = The shade and size are changed by VO.

#### 12.4. Screen Cosmetic Criteria (Operating) (Continued)

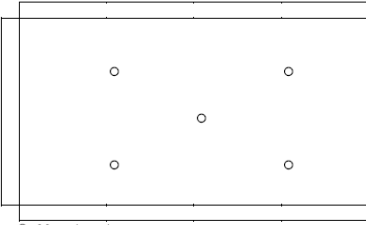
| No. | Defect   | Judgment Criterion  | Partition |
|-----|--|---|-----------|
| 3   | Rubbing line                                     | Not to be noticeable.   |           |
| 4   | Allowable density                                | Above defects should be separated more than 10mm each other.  | Minor     |
| 5   | Rainbow  | Not to be noticeable.   | Minor     |
| 6   | Dot size   | To be 95% ~ 105% of the dot size (Typ.) in drawing. Partial defects of each dot (ex. pin-hole) should be treated as 'Spot'. (see <i>Screen Cosmetic Criteria (Operating) No.1</i> )   | Minor     |
| 7   | Uneven brightness<br>(only back-lit type module) | <p>Uneven brightness must be <math>B_{MAX} / B_{MIN} \leq 2</math></p> <ul style="list-style-type: none"> <li>- <math>B_{MAX}</math> : Max. value by measure in 5 points</li> <li>- <math>B_{MIN}</math> : Min. value by measure in 5 points</li> </ul> <p>Divide active area into 4 vertically and horizontally. Measure 5 points shown in the following figure.</p> <div style="text-align: center;">  <p>○ : Measuring points</p> </div> | Minor     |

Note :

- (1) Size :  $d = (\text{long length} + \text{short length}) / 2$
- (2) The limit samples for each item have priority.
- (3) Complexed defects are defined item by item, but if the number of defects are defined in above table, the total number should not exceed 10.
- (4) In case of 'concentration', even the spots or the lines of 'disregarded' size should be not allowed. Following three situations should be treated as 'concentration'.
  - 7 or over defects in circle of '5mm.
  - 10 or over defects in circle of '10mm.
  - 20 or over defects in circle of '20mm.

### 13. PRECAUTIONS FOR USING LCD MODULES

#### Handing Precautions

- (1) The display panel is made of glass. Do not subject it to a mechanical shock by dropping it or impact.
- (2) If the display panel is damaged and the liquid crystal substance leaks out, be sure not to get any in your mouth. If the substance contacts your skin or clothes, wash it off

---

---

using soap and water.

(3) Do not apply excessive force to the display surface or the adjoining areas since this may cause the color tone to vary.

(4) The polarizer covering the display surface of the LCD module is soft and easily scratched. Handle this polarizer carefully.

(5) If the display surface becomes contaminated, breathe on the surface and gently wipe it with a soft dry cloth. If it is heavily contaminated, moisten cloth with one of the following solvents :

- Isopropyl alcohol
- Ethyl alcohol

(6) Solvents other than those above-mentioned may damage the polarizer. Especially, do not use the following.

- Water
- Ketone
- Aromatic solvents

(7) Exercise care to minimize corrosion of the electrode. Corrosion of the electrodes is accelerated by water droplets, moisture condensation or a current flow in a high-humidity environment.

(8) Install the LCD Module by using the mounting holes. When mounting the LCD module make sure it is free of twisting, warping and distortion. In particular, do not forcibly pull or bend the IO cable or the backlight cable.

(9) Do not attempt to disassemble or process the LCD module.

(10) NC terminal should be open. Do not connect anything.

(11) If the logic circuit power is off, do not apply the input signals.

(12) To prevent destruction of the elements by static electricity, be careful to maintain an optimum work environment.

- Be sure to ground the body when handling the LCD modules.
- Tools required for assembling, such as soldering irons, must be properly grounded.
- To reduce the amount of static electricity generated, do not conduct assembling and other work under dry conditions.

- The LCD module is coated with a film to protect the display surface. Exercise care when peeling off this protective film since static electricity may be generated.

### **Storage Precautions**

When storing the LCD modules, avoid exposure to direct sunlight or to the light of fluorescent lamps. Keep the modules in bags (avoid high temperature, high humidity and low temperatures below 0°C). Whenever possible, the LCD modules should be stored in the same conditions in which they were shipped from our company.

### **Others**

Liquid crystals solidify under low temperature (below the storage temperature range) leading to defective orientation or the generation of air bubbles (black or white). Air bubbles may also be generated if the module is subject to a low temperature.

If the LCD modules have been operating for a long time showing the same display

---

patterns, the display patterns may remain on the screen as ghost images and a slight contrast irregularity may also appear. A normal operating status can be regained by suspending use for some time. It should be noted that this phenomenon does not adversely affect performance reliability.

To minimize the performance degradation of the LCD modules resulting from destruction caused by static electricity etc., exercise care to avoid holding the following sections when handling the modules.

- Exposed area of the printed circuit board.
- Terminal electrode sections.

## 14. USING LCD MODULES

### Liquid Crystal Display Modules

LCD is composed of glass and polarizer. Pay attention to the following items when handling.

- (1) Please keep the temperature within specified range for use and storage. Polarization degradation, bubble generation or polarizer peel-off may occur with high temperature and high humidity.
- (2) Do not touch, push or rub the exposed polarizers with anything harder than an HB pencil lead (glass, tweezers, etc.).
- (3) N-hexane is recommended for cleaning the adhesives used to attach front/rear polarizers and reflectors made of organic substances which will be damaged by chemicals such as acetone, toluene, ethanol and isopropylalcohol.
- (4) When the display surface becomes dusty, wipe gently with absorbent cotton or other soft material like chamois soaked in petroleum benzin. Do not scrub hard to avoid damaging the display surface.
- (5) Wipe off saliva or water drops immediately, contact with water over a long period of time may cause deformation or color fading.
- (6) Avoid contacting oil and fats.
- (7) Condensation on the surface and contact with terminals due to cold will damage, stain or dirty the polarizers. After products are tested at low temperature they must be warmed up in a container before coming is contacting with room temperature air.
- (8) Do not put or attach anything on the display area to avoid leaving marks on.
- (9) Do not touch the display with bare hands. This will stain the display area and degradate insulation between terminals (some cosmetics are determined to the polarizers).
- (10) As glass is fragile. It tends to become or chipped during handling especially on the edges. Please avoid dropping or jarring.

### Installing LCD Modules

The hole in the printed circuit board is used to fix LCM as shown in the picture below. Attend to the following items when installing the LCM.

- (1) Cover the surface with a transparent protective plate to protect the polarizer and LC cell.

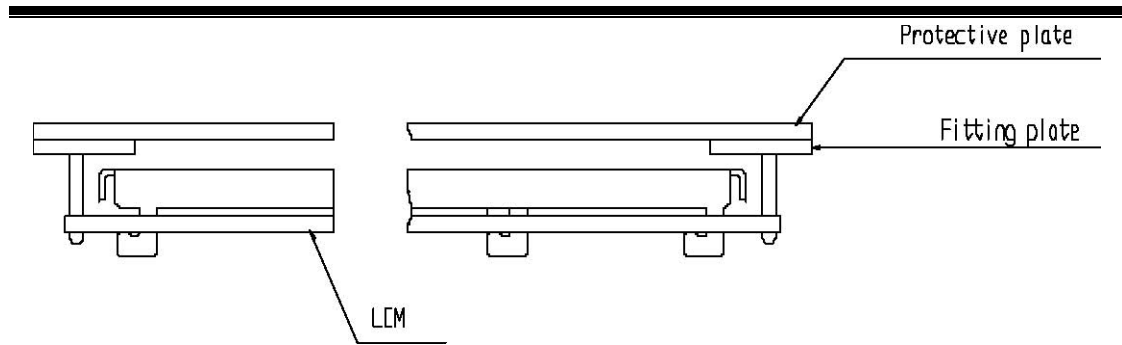

(2) When assembling the LCM into other equipment, the spacer to the bit between the LCM and the fitting plate should have enough height to avoid causing stress to the module surface, refer to the individual specifications for measurements. The measurement tolerance should be 0.1mm.

### **Precaution for Handling LCD Modules**

Since LCM has been assembled and adjusted with a high degree of precision, avoid applying excessive shocks to the module or making any alterations or modifications to it.

- (1) Do not alter, modify or change the the shape of the tab on the metal frame.
- (2) Do not make extra holes on the printed circuit board, modify its shape or change the positions of components to be attached.
- (3) Do not damage or modify the pattern writing on the printed circuit board.
- (4) Absolutely do not modify the zebra rubber strip (conductive rubber) or heat seal connector.
- (5) Except for soldering the interface, do not make any alterations or modifications with a soldering iron.
- (6) Do not drop, bend or twist LCM.

### **Electro-Static Discharge Control**

Since this module uses a CMOS LSI, the same careful attention should be paid to electrostatic discharge as for an ordinary CMOS IC.

- (1) Make certain that you are grounded when handling LCM.
- (2) Before remove LCM from its packing case or incorporating it into a set, be sure the module and your body have the same electric potential.
- (3) When soldering the terminal of LCM, make certain the AC power source for the soldering iron does not leak.
- (4) When using an electric screwdriver to attach LCM, the screwdriver should be of ground potentiality to minimize as much as possible any transmission of electromagnetic waves produced sparks coming from the commutator of the motor.
- (5) As far as possible make the electric potential of your work clothes and that of the work bench the ground potential.
- (6) To reduce the generation of static electricity be careful that the air in the work is not too dried. A relative humidity of 50%60% is recommended.

### **Precaution for soldering to the LCM**

- (1) Observe the following when soldering lead wire, connector cable and etc. to the LCM.



- Soldering iron temperature : 280°C ± 10°C.
- Soldering time : 3-4 sec.
- Solder : eutectic solder.

If soldering flux is used, be sure to remove any remaining flux after finishing to soldering operation. (This does not apply in the case of a non-halogen type of flux.) It is recommended that you protect the LCD surface with a cover during soldering to prevent any damage due to flux spatters.

(2) When soldering the electroluminescent panel and PC board, the panel and board should not be detached more than three times. This maximum number is determined by the temperature and time conditions mentioned above, though there may be some variance depending on the temperature of the soldering iron.

(3) When remove the electroluminescent panel from the PC board, be sure the solder has completely melted, the soldered pad on the PC board could be damaged.

#### Precautions for Operation

(1) Viewing angle varies with the change of liquid crystal driving voltage (VO). Adjust VO to show the best contrast.

(2) Driving the LCD in the voltage above the limit shortens its life.

(3) Response time is greatly delayed at temperature below the operating temperature range. However, this does not mean the LCD will be out of the order. It will recover when it returns to the specified temperature range.

(4) If the display area is pushed hard during operation, the display will become abnormal. However, it will return to normal if it is turned off and then back on.

(5) Condensation on terminals can cause an electrochemical reaction disrupting the terminal circuit. Therefore, it must be used under the relative condition of 40°C, 50% RH.

(6) When turning the power on, input each signal after the positive/negative voltage becomes stable.

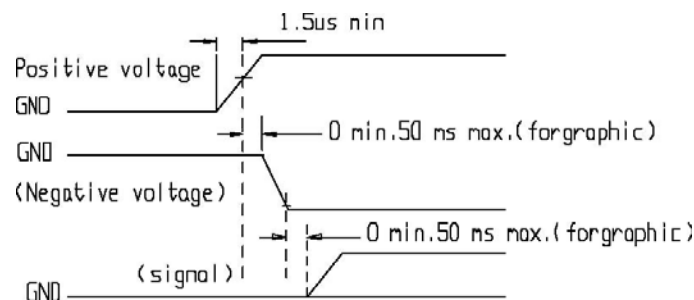

#### Storage

When storing LCDs as spares for some years, the following precaution are necessary.

(1) Store them in a sealed polyethylene bag. If properly sealed, there is no need for dessicant.

(2) Store them in a dark place. Do not expose to sunlight or fluorescent light, keep the temperature between 0°C and 35°C.

(3) The polarizer surface should not come in contact with any other objects. (We advise you to store them in the container in which they were shipped.)

#### Safety

---

(1) It is recommended to crush damaged or unnecessary LCDs into pieces and wash them off with solvents such as acetone and ethanol, which should later be burned.

(2) If any liquid leaks out of a damaged glass cell and comes in contact with the hands, wash off thoroughly with soap and water.

**Return LCM under warranty**

No warranty can be granted if the precautions stated above have been disregarded.

The typical examples of violations are :

- Broken LCD glass.
- PCB eyelet's damaged or modified.
- PCB conductors damaged.
- Circuit modified in any way, including addition of components.
- PCB tampered with by grinding, engraving or painting varnish.
- soldering to or modifying the bezel in any manner.

Module repairs will be invoiced to the customer upon mutual agreement. Modules must be returned with sufficient description of the failures or defects. Any connectors or cable installed by the customer must be removed completely without damaging the PCB eyelet's, conductors and terminals.

## 液晶显示模块使用注意事项

1. 请勿随意自行加工、整修、拆卸。
2. 避免对液晶屏表面施加压力。
3. 不要用手随意去摸外引线、电路板上的电路及金属框。
4. 如必须直接接触时，应使人体与模块保持同一电位，或将人体良好接地。
5. 焊接使用的烙铁、操作用的电动改锥等工具必须良好接地，没漏电。
6. 严防各种静电。
7. 模块使用接入电源及断开电源时，必须按图时序进行。即必须在正电源（ $5 \pm 0.25V$ ）稳定接入后，才能输入信号电平。如在电源稳定接入前，或断开后就输入信号电平，将会损坏模块中的集成电路，使模块损坏。

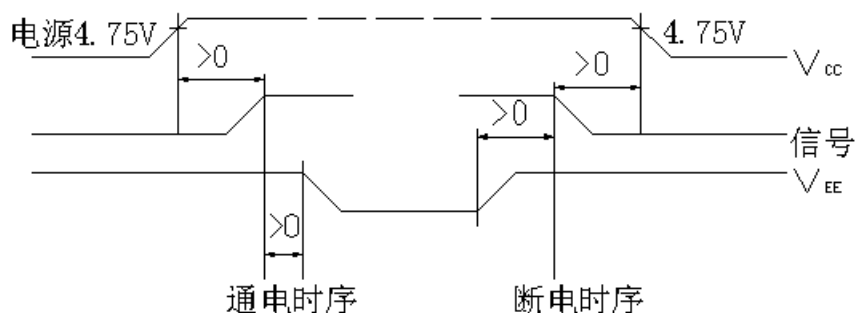

8. 点阵模块在调节时，应调整 VEE 至最佳对比度、视角时为止。如果 VEE 调整过高，不仅会影响显示，还会缩短液晶的寿命。
9. 模块表面结雾时，不要通电工作，因为这将引起电极化学反应，产生断线。
10. 模块要存储在暗处（避阳光），温度在 $-10^{\circ}\text{C} \sim +35^{\circ}\text{C}$ ，湿度在 RH60%以上的地方。如能装入聚乙烯口袋（最好有防静电涂层）并将口封住最好。

以上使用说明由北京中显电子有限公司编制，有问题请电话联络，我们将竭诚为您服务，同时，提供完善的保修服务！因为每种液晶使用的控制器都不一样，控制器的型号基本就决定了液晶的指令形式和使用方式，所以，在说明书里一般不会详细照搬控制器说明书的每个细节，只会简要介绍常用指令，如果需要了解详细的指令和具体电气参数，请参照 [WWW.ZXLCD.COM](http://WWW.ZXLCD.COM) 网站里的“技术支持”菜单下，均有对应控制器手册免费下载，直接对应现有各类液晶使用的各种控制器，使用手册里一般有具体电气参数说明，指令详细介绍，同时辅以编程实例，以便客户详细参照，同时提高编程及操作技巧。

服务电话：010-52926620, 82626833

公司地址：北京市中关村大街 32 号蓝天和盛大厦 811 室